

THE URBAN TRANSPORTATION REVOLUTION COMING TO YOUR CITY

# LOOPWAY



#Autonomous

#All electric

#Faster

# Contents

A MULTI-MODE URBAN TRANSIT SYSTEM FOR YOUR CITY

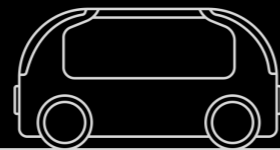

LOOPWAY

## 📍 Introduction

- About Loopway
- Vision
- Last-mile connectivity
- How it works
- Powered by Loopway

## 📍 Services

- Service models and solutions
- Path to build for your city
- Business model

## 📍 Vision to Reality

- Tunnel Development
- Autonomous drive
- Substation design
- All electric mobility. Loopway POD
- Digital Products

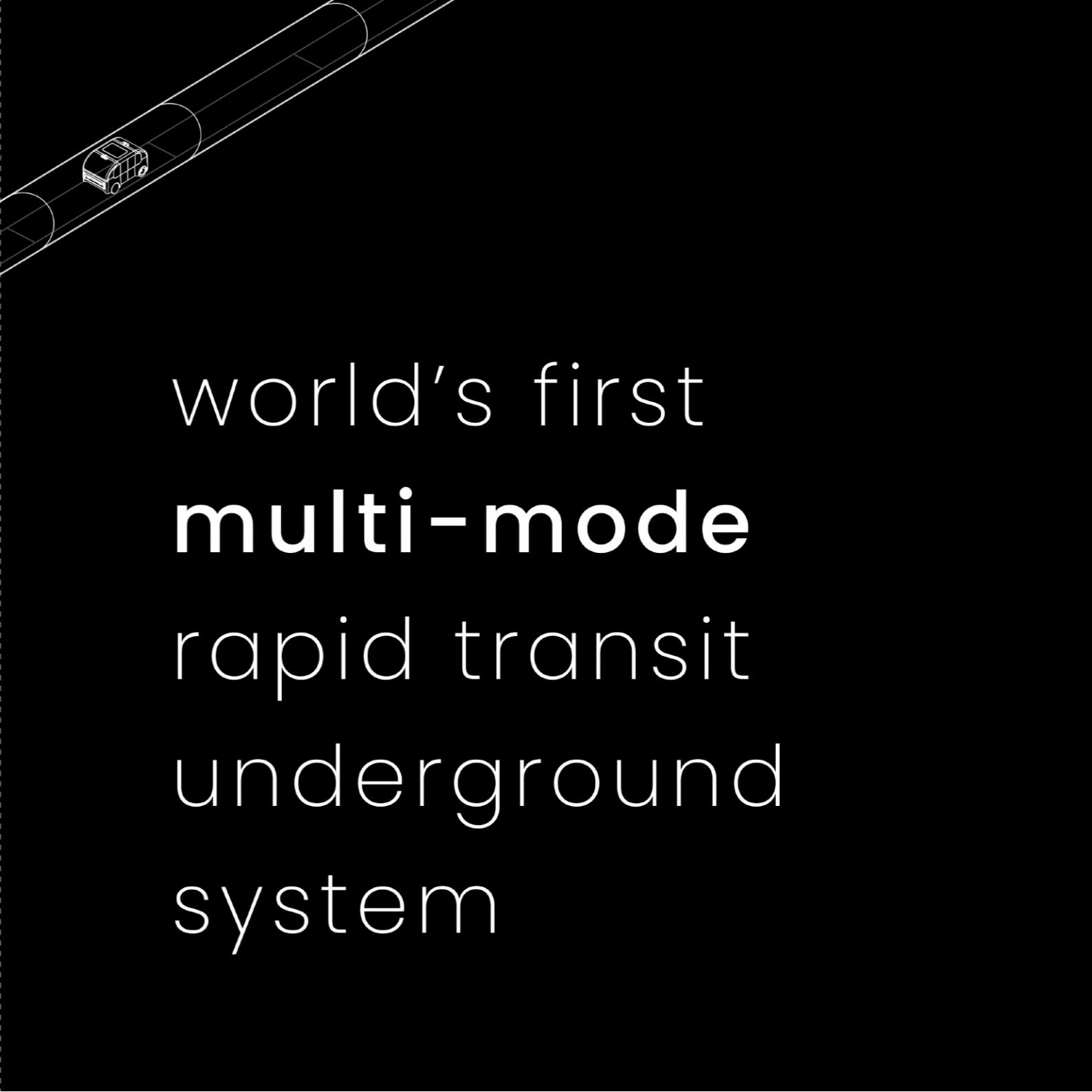
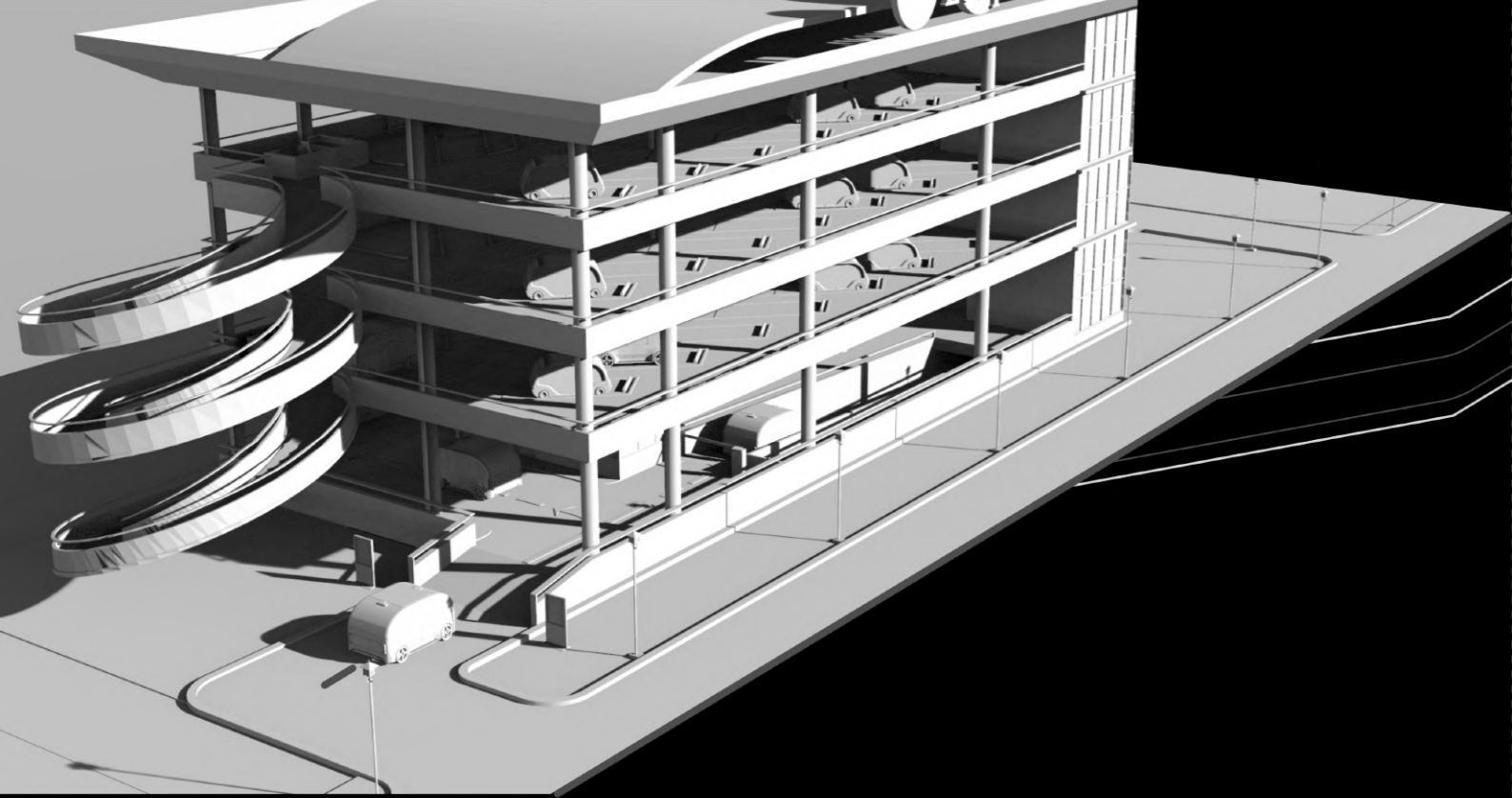

📍 We are rethinking urban mobility and its surrounding environment for an efficient and sustainable Right of Way

LOOPWAY

world's first  
**multi-mode**  
rapid transit  
underground  
system

# At Loopway

We are building a Multi-Mode Underground Transit System specifically designed for use in the urban environment using micro tunnels for Right of Way (ROW), Autonomous Vehicles, Electric vehicles, and V2I platforms...

Compared with other Mass Transit options like MRTS (Mass Rapid Transit System) and BRTS (Bus Rapid Transit System), the Loopway system is more efficient in building and operating. In addition, the system enables private transit integration allowing higher revenue and lower running costs. Leveraging radical modern technologies, we are rethinking how a mass transit system and Right of Way (ROW) should work to meet the alarming present challenges in urban cities for a clean, green and sustainable future.

**50%**

less cost to build

**3x** more revenue  
per passenger

Multi-use capability for Right of Way Lanes

**70%**

less land requirement

As compared to the traditional mass transit systems. The Loopway system can scale up vertically to add more lanes without extra overheads

**>50%**

Private stakeholders

can participate in building the infrastructure at higher ownership reducing government overhead, maximum revenue potential

**Made in India**

Technology products designed and developed in India

**Efficient, Faster, No stop travel**



**Fully Autonomous**

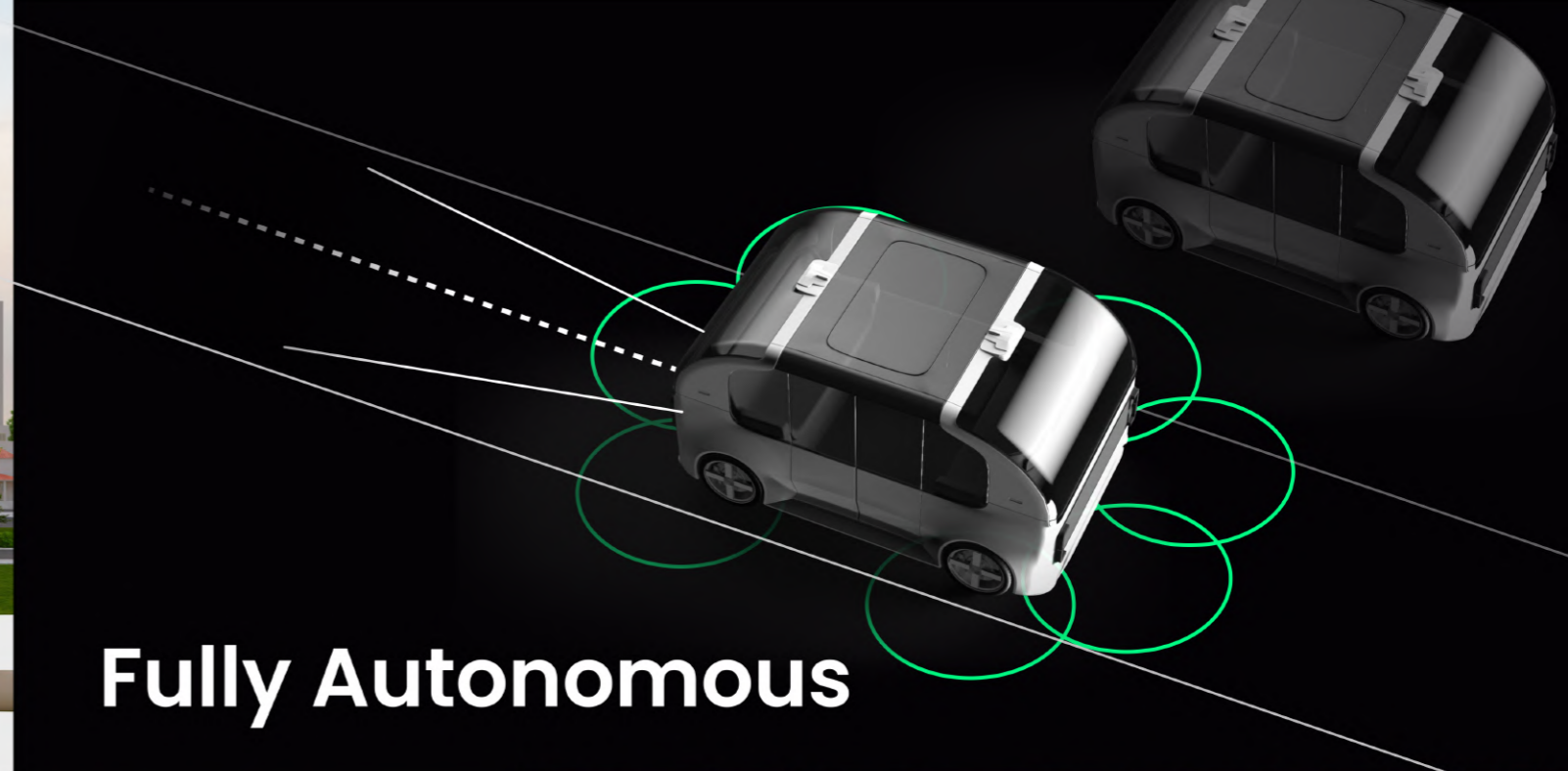

**Connected**

**All Electric**



**Green futures**



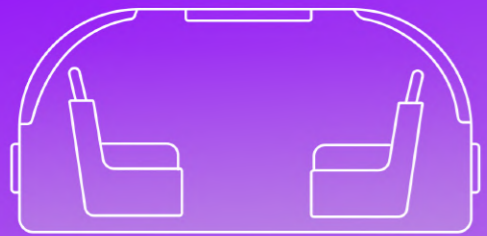

TRAVEL

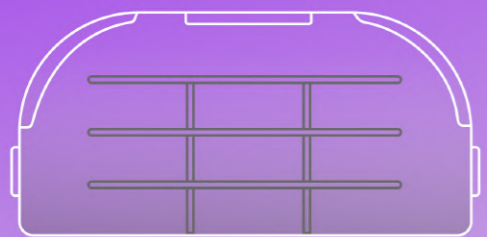

FREIGHT AND LOGISTICS

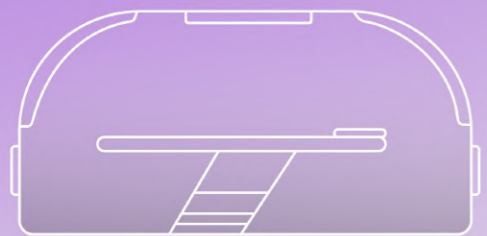
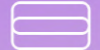

MEDICAL



**Ground-up  
Modularity**

# Fully underground

NO TRAFFIC CONGESTION

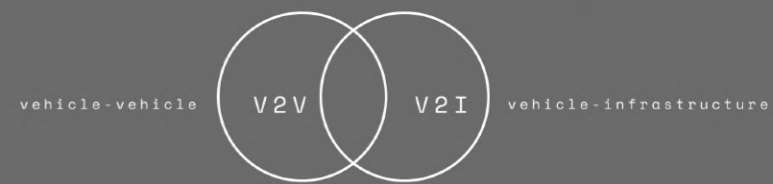
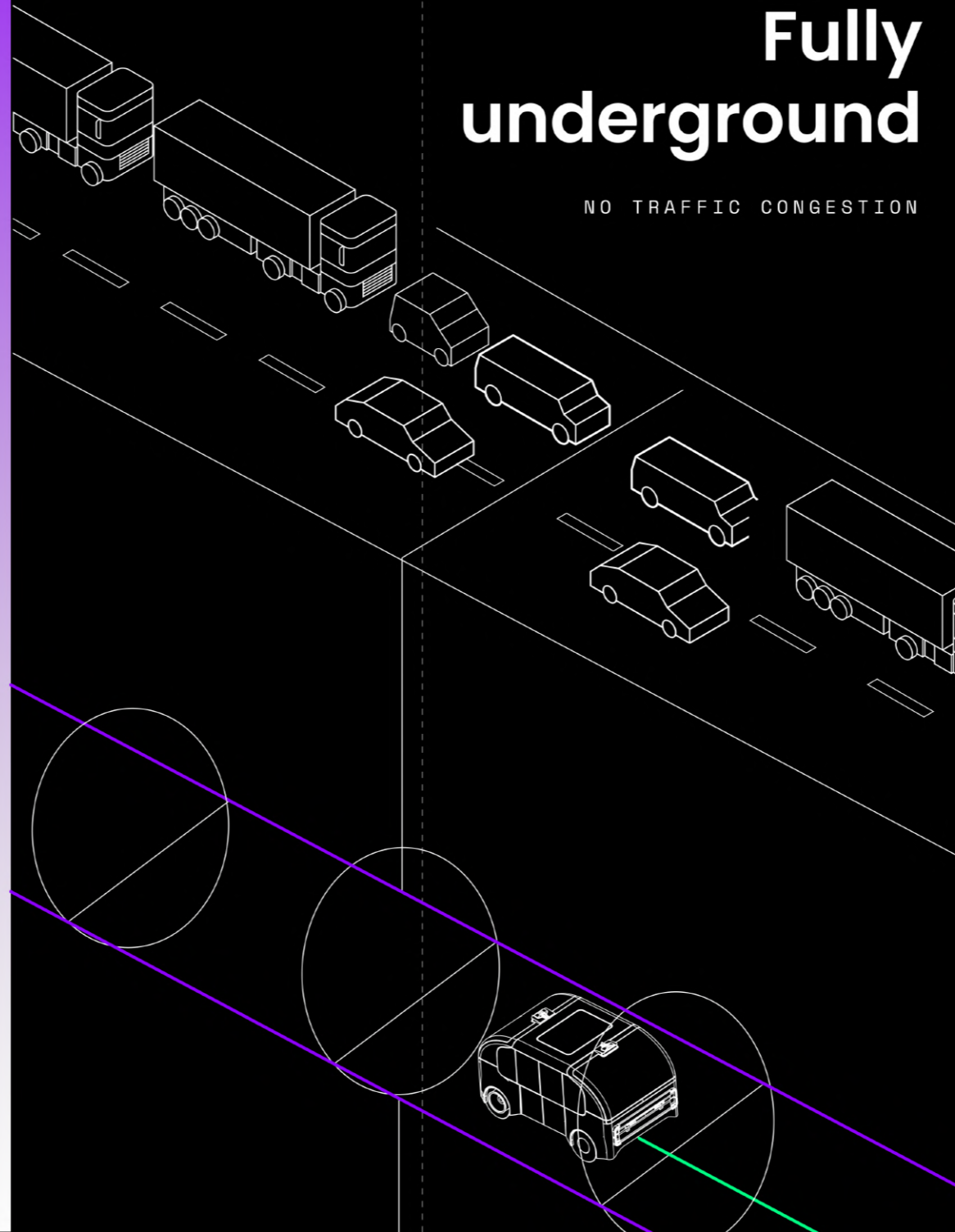

## Safe and reliable



Riders-first,  
Enjoyable travel experience

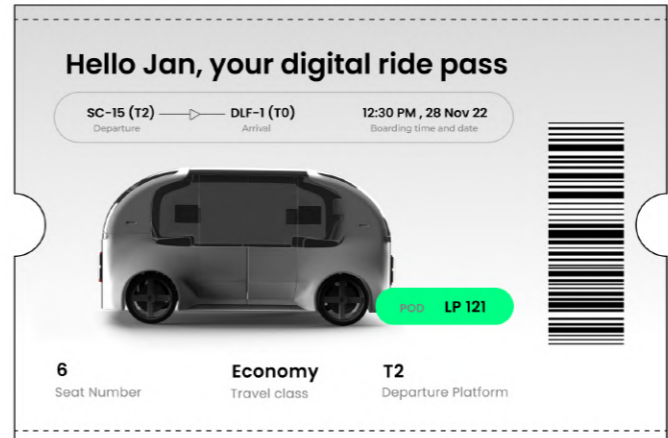

Easy  
ride-hailing

ACCESSIBLE ANYTIME ANYWHERE

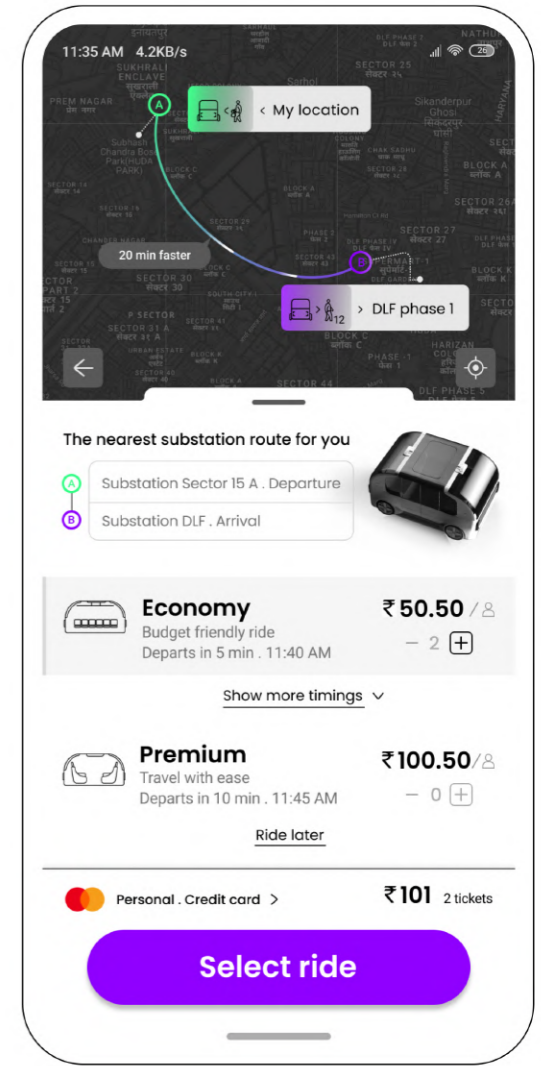

Sustainable mobility

# Vision

ABOUT LOOPWAY

CLEAN CITIES

LESS TRAFFIC CONGESTION

SAFE TRAVEL

## A clean micro-mobility designed for the urban environment

Road transportation accounts for 15 % of global CO<sub>2</sub> emissions. Revolutionising urban travel and rethinking the Right-of-Way for an intelligent transit system for shared, personal and commercial mobilities. Our wide-scale electrification and automation to build, scale-up and operate underground loops will help to lower carbon emissions and reduce air pollution in our cities.

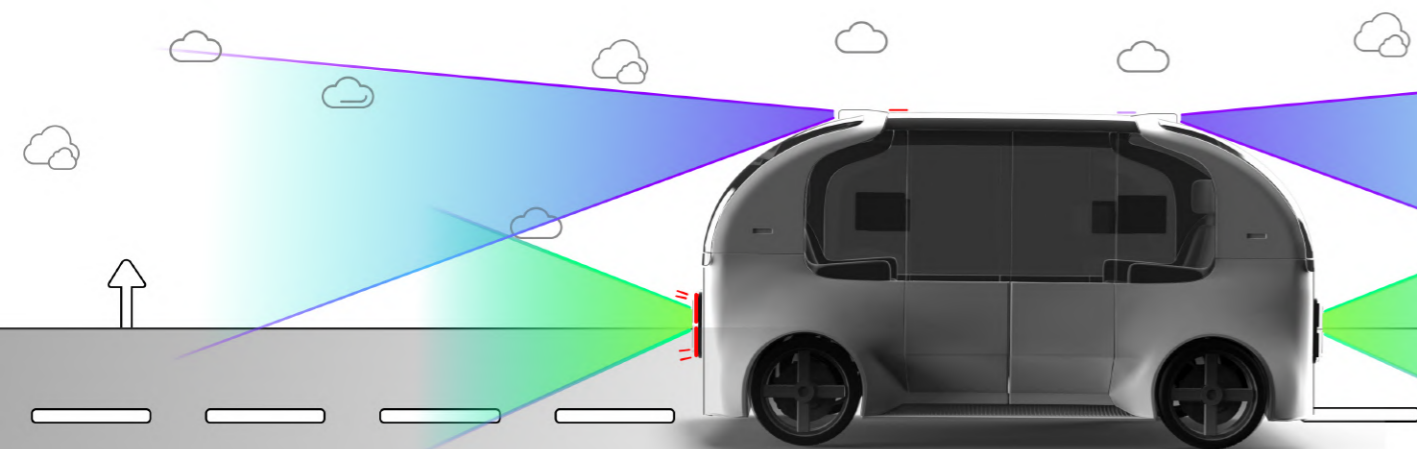

WHY LOOPWAY

## A multi-mode transit system

AUTONOMOUS DRIVE

ELECTRIC VEHICLES

MICRO TUNNELS

The loopway system seamlessly merges the existing urban road transit system with the underground tunnel loops for faster, safer and more efficient intra-city travel. The traffic management system manages the autonomous drive of our connected vehicles travelling underground in the dedicated high-speed Right-of-Way. Electric cars powered by the Loopway's autonomous drive can run on the roads and simultaneously use the high-speed driverless underground loops to reach their destination earlier. Our system solves the growing city traffic problem and the end-mile connectivity for travellers.

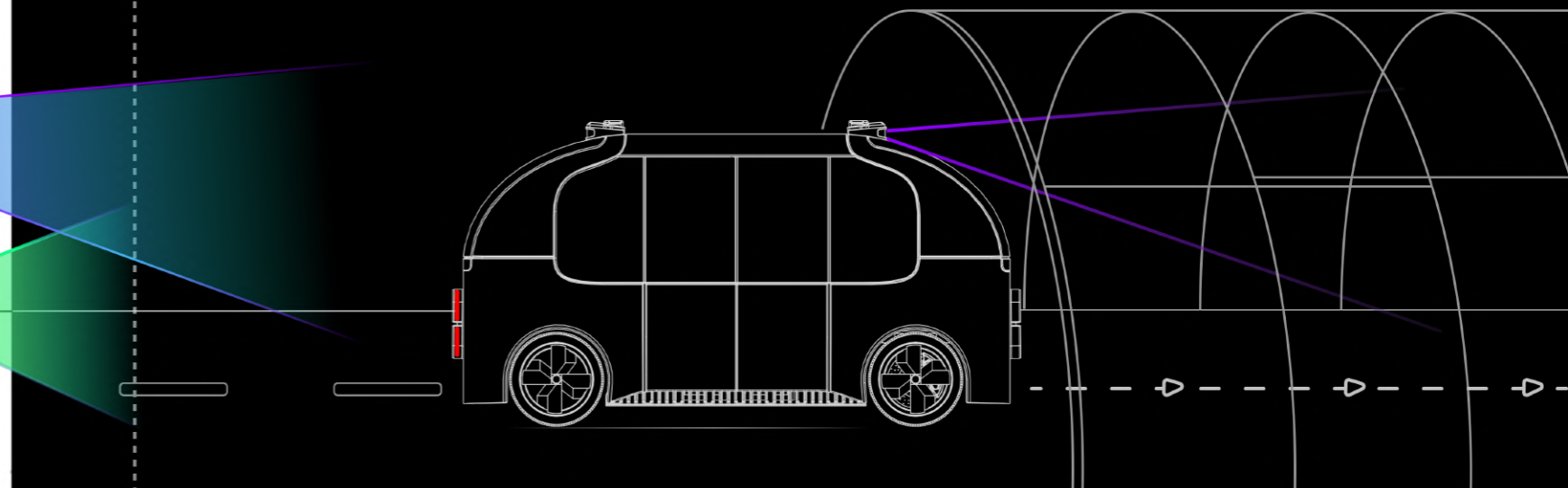



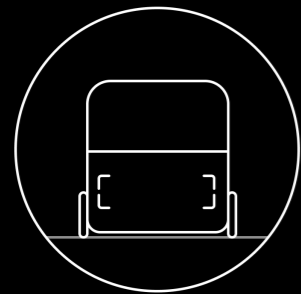

4 meters

LOOPWAY micro tunnel

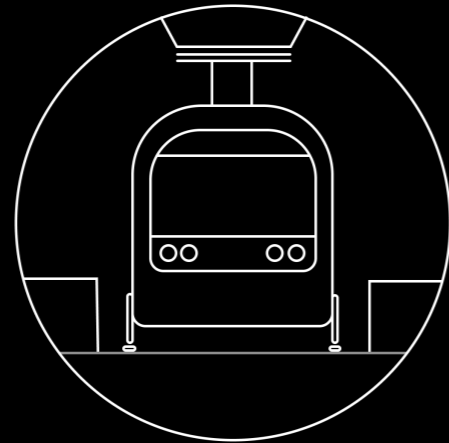

5.5 - 6.5 meters

A subway or metro tunnel width

## Micro tunnels for end-to-end mobility

LOOPWAY

WHY LOOPWAY

# An exponential decrease in boring cost

AUTOMATION

EFFICIENCY

ELECTRIC

LESS TUNNEL DIAMETER, LESS CONSTRUCTION COSTS

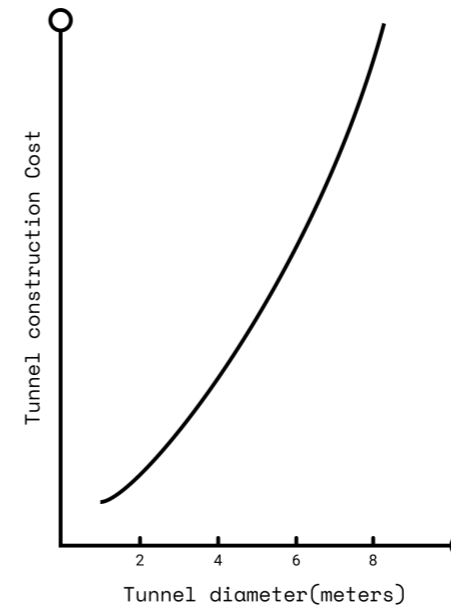

**Reimagining urban mass transit needs a radical new approach for efficient, circular and sustainable green futures.**

At Loopway, we have re-engineered and optimized the boring technologies from the ground up, making them suitable to use in the urban environment. Modular and autonomous robotic arms for reinforcement and 100% electrification for zero emissions. Besides, an exponential reduction in tunnel construction costs by reducing the tunnel diameter and designing micro mobility for micro tunnels having width less than 4 meters.

# How it works

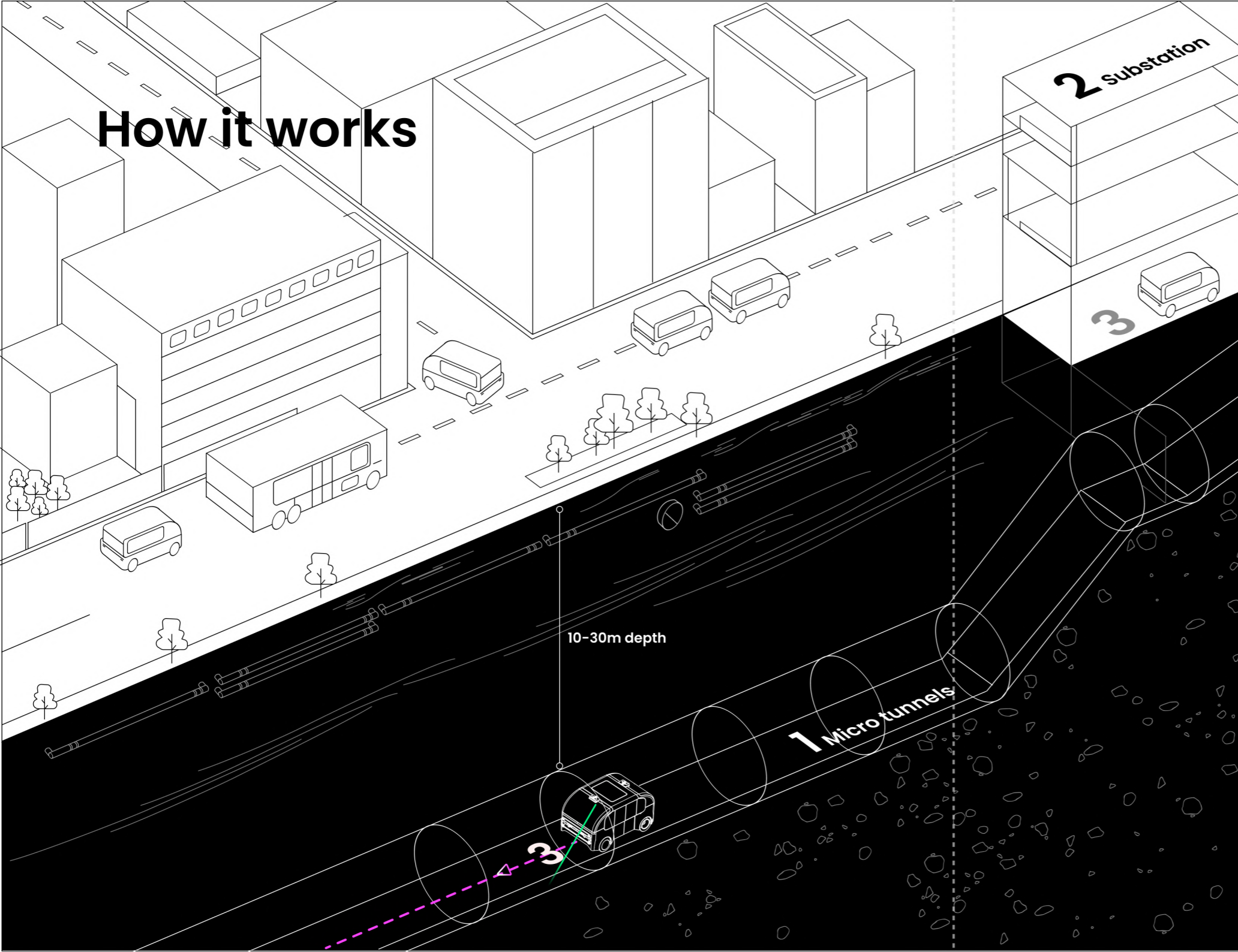

## SYSTEM OVERVIEW

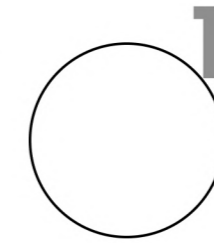

### Micro tunnels

A closed and controlled environment helps to achieve autonomous drive without human control and achieve high speeds with predicted tunnel environment and artificial intelligence. The tunnels are equipped with V2I sensors, lidars and cameras to communicate with the traffic management system.



### Vertical substation

The substation seamlessly connects the underground tunnels with the city's existing transit system with ground floor connected to the road network. Being built vertically, it occupies less real estate and each level is assigned to different mobility usecase. The substation control room manages the incoming/outgoing traffic and overall fleet operations.

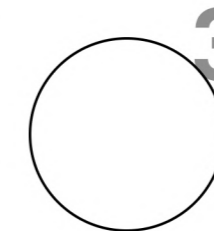

### Autonomous and Emission free vehicles

Without human intervention, electric and emission-free vehicles can fully self-drive in our closed underground environment. Being carbon neutral helps reduce city pollution levels, and advanced self-driving brings new levels of safety and convenience while travelling.

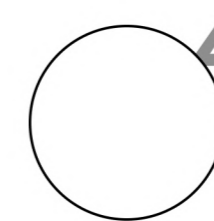

### Digital products

Our range of digital products helps the passengers and the users stay connected with our services. For an enhanced experience, the users are always connected with our POD and informed about their trips. Hail a shared or private ride anytime anywhere.

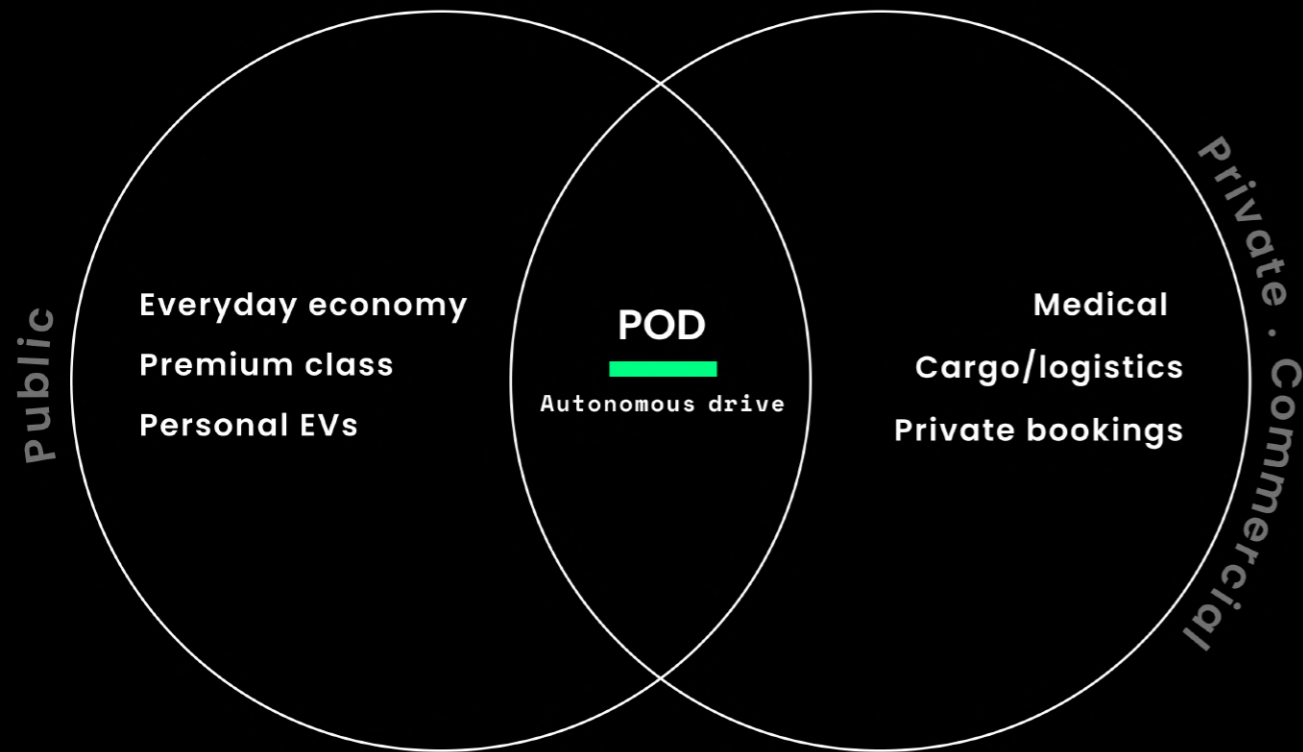

A multi-mode transit system in shared ROW (Right of way)

LOOPWAY

## Powered by Loopway

### Modular electric platform

Our unified approach to ground-up modularity. A single POD platform with minor interior modifications can be used for diverse usecases

### Shared Right-of-way

Closed and controlled environments equipped with advanced 5g/Lifi and V2I sensors suite for efficient wireless communication and traffic management. Smart tunnel lighting for energy optimisation, mechanical towing for uncertain breakdowns and emergency exits for the passengers

### V2I suite & V2V vehicle connectivity

Powered by advanced communications, robotics and sensors, the traffic management system can autonomously handle the operations of the substation with minimal human effort.

### Charging Grid

Quick charge and efficient power-share to maximise charging multiple vehicles simultaneously.

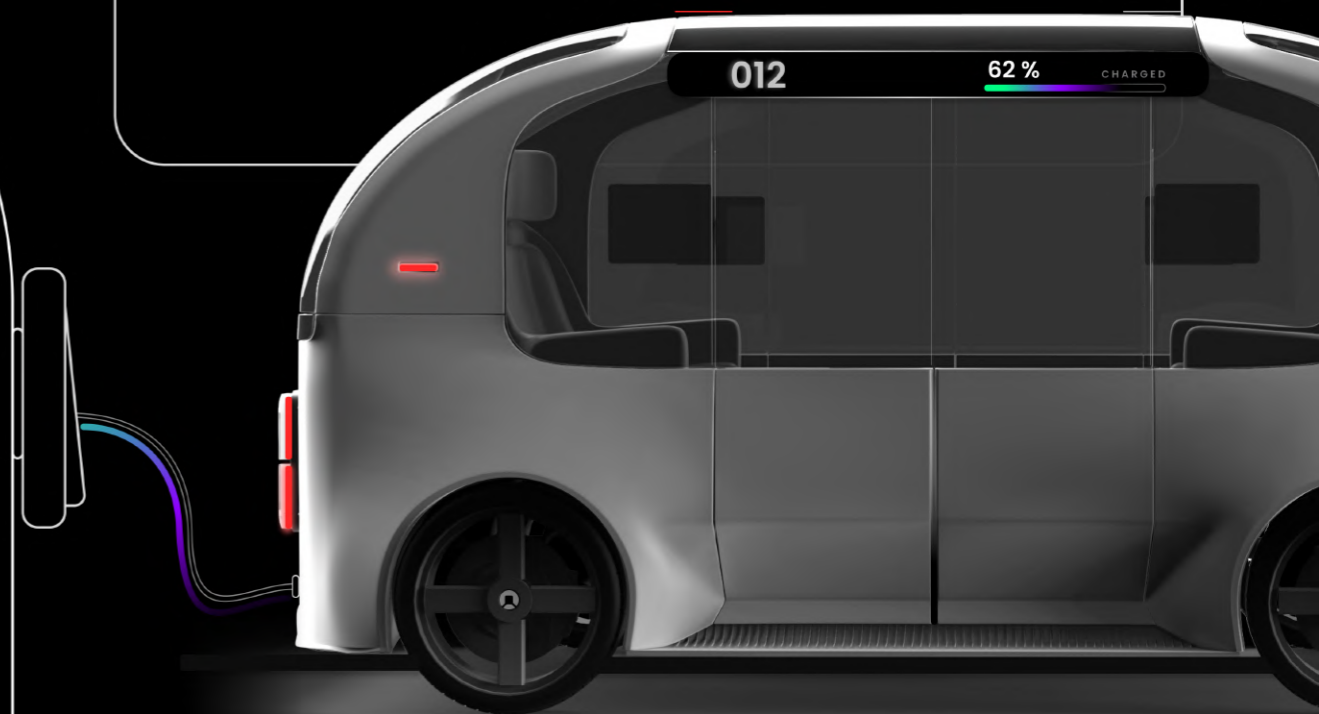

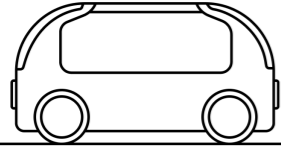

# Mass transit

## Shared mobility . Economy

Budget-friendly regular commute for work or personal needs. Our electric PODs can carry upto 16 passengers(Standing basis) and 8 passengers (Seated basis).

## Shared mobility . Premium

Our micro-mobility premium service offers a luxurious, enjoyable and a more comfortable with a allocated personal cabin space in our PODs. A finest one-of-a-kind travel experience crafted for users looking for extra comfort, elderly or special needs.

## Dedicated mobility

Our electric POD will drive you in luxury to any destination you want. Pre booked on-demand for a group of friends or personal needs, hail our entire POD, to sit back, relax and dine in style while you travel with Loopway.

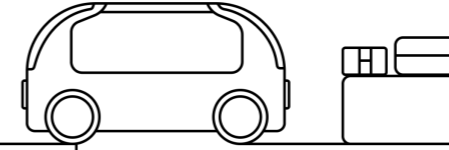

# Private/Commercial transit

## Logistics and Businesses

Explore loopway freight shipping and logistics solutions for rapid intra-city service. Small businesses and global logistics companies(DHL/Bluedart) can use the cargo terminals in our substation with modular POD transport platform to deliver goods faster than ever !!

## Emergency Medical Services

Loopway transit system is deeply connected with Emergency health services for availing Ambulances, Organ or Blood transport with the highest given priority in our shared ROW. Our tunnel network will be connected to the partner hospitals bringing healthcare closer to the patients.

## Private Taxi Mobility

Bridging the end-mile connectivity, EVs powered by Loopway's autonomous drive suite can use the shared ROW for seamless travel. The private taxi can be driven on road to the nearest substation by driver, travels autonomus in the loopway's underground tunnels and merges with the road traffic to reach the destination. Beat the city traffic and travel more in less time, we estimate that this enhances the trip efficiency by 3X.

# Services

A T L O O P W A Y

## digitize and demontize the urban mobility industry

3x

less land needed for tunnels than elevated corridors

2x

less space for the vertical substation construction

1/5

of total real estate needed than MRTS

5x

less cost to build the system

## Plan

### CONSULTING PROGRAM

Our consulting and planning assists your city in feasibility studies, financial reports, and detailed project reports. We produce detailed plans including feasible routes, no of substations required, tunnel specifications, soil reports, and estimated final costs for the entire system to build.

## Fund

### FACILITATOR PROGRAM

As facilitators, we provide an entire legal framework to set up the company and raise the required funding needed through Equity funding, Bond Holder funding, private partnership funding and Government funding. As facilitators, we also provide the estimated revenue and ROI ( Return On Investment) values, and interest payment on Bonds and dividends for equities.

## Build

### IMPLEMENTATION PROGRAM

This is a turn-key solution where we provide all aspects to build loopway system in your city. We partnered with companies that are leaders and innovators in their respective fields to execute the project. Loopway provides services to build tunnels, build substations equipped with the required V2I (Vehicle to infra) sensors and selected features in the tunnel. We will also provide the required software to run the platform (Traffic Management System), provide Autonomous Electric Vehicles and Digital Apps to integrate the bookings, payments and tracking system.

## Operate

### OPERATIONS PROGRAM

Once the system is built, we provide the operations, training and support services to run and maintain the system efficiently. Our digital products and powerful APIs helps in seamless booking, platform integration and monitor fleet operations.

# Loopway's turn-key solution for the entire system

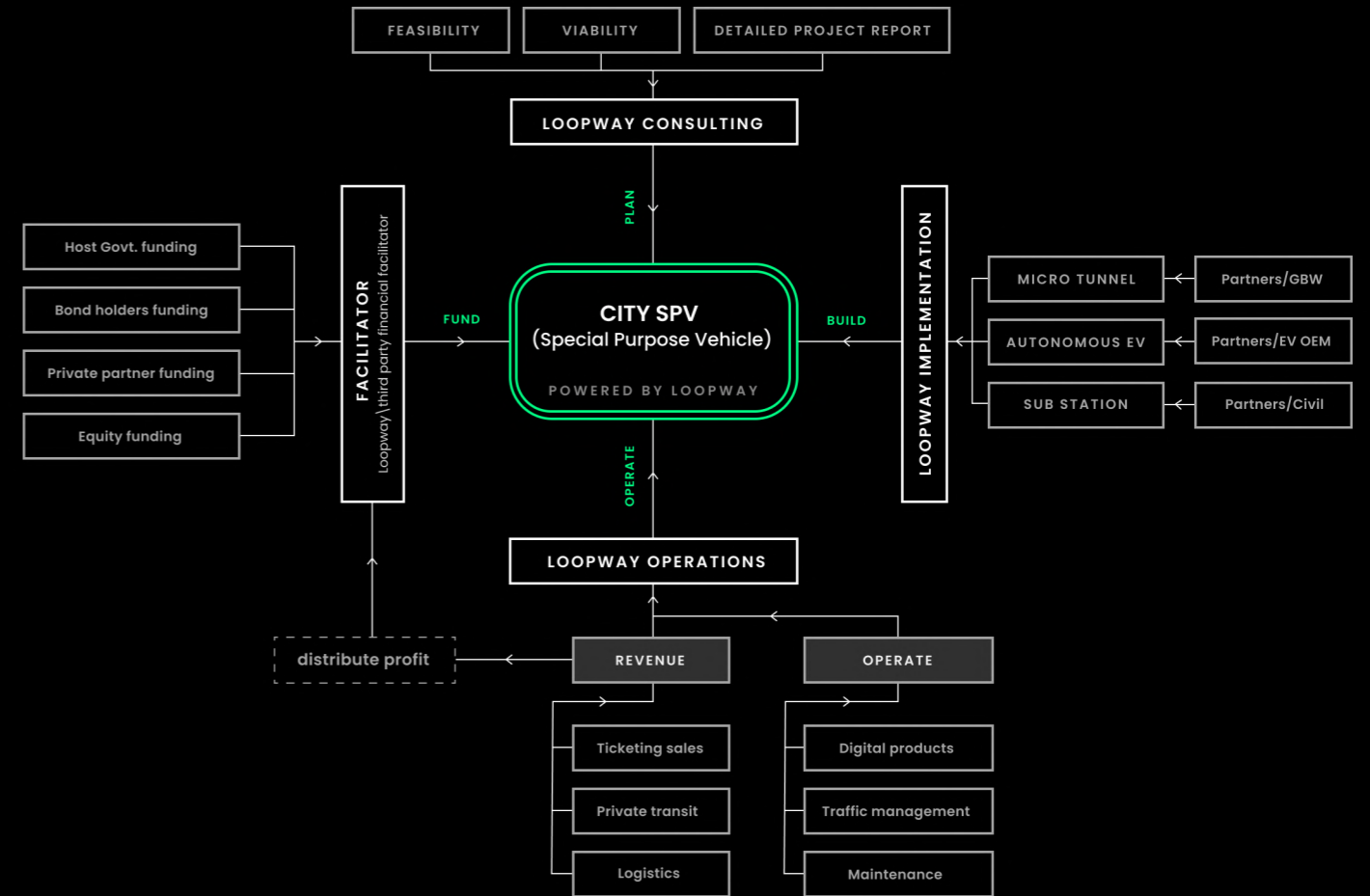
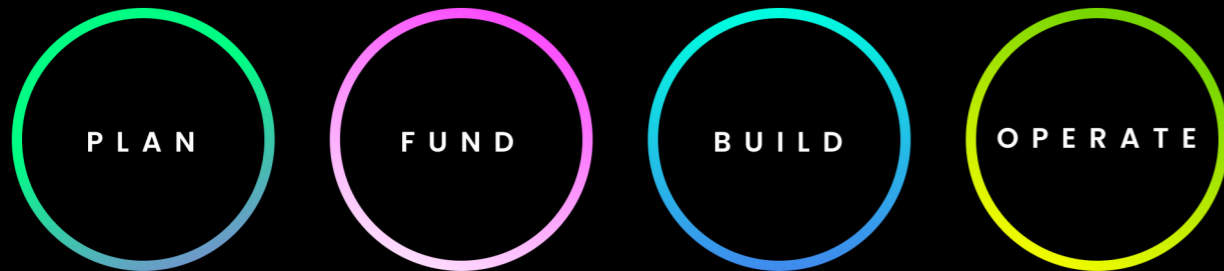

Path to build for your city

LOOPWAY

# Bussiness Model

Being a mixed-mode transit system, Loopway is India's first financially feasible infrastructure project against the existing public transportation. Collaboration with industry leading partners and deep integration with the private stakeholders, we can build the entire system using the Special Purpose Investment Vehicle as illustrated below to plan, fund, build and operate.

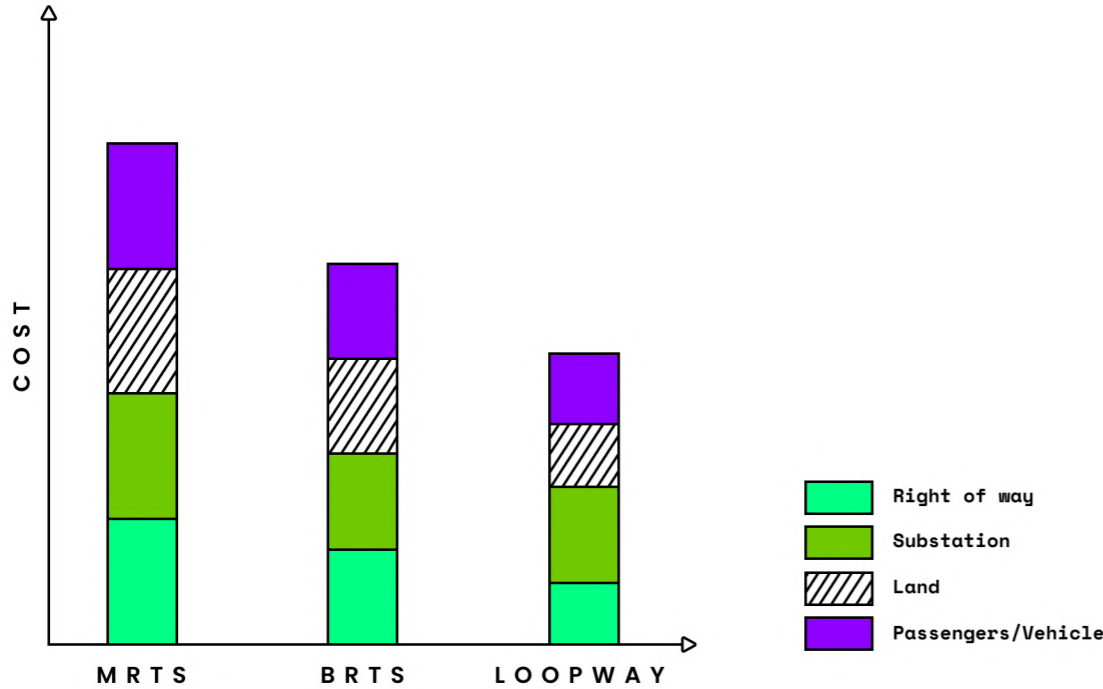

### Comparsion the different types of exisiting public transit systems

The above bar graph makes an apples to apples cost comparison between the Loopway transit system and, existing MRTS and BRTS system. The calculated cost breakup is based on a two-way 10 km journey having 5 substations and 4000 passengers/hour capacity.

# Higher private stakeholders participation from the start

PUBLIC PRIVATE PARTNERSHIP

PRIVATE CIVIL-INFRASTRUCTURE

How ?  
Our systems strategy eliminates the shortcomings of the public transportation projects. With

Lesser operations cost,  
higher revenue per passenger

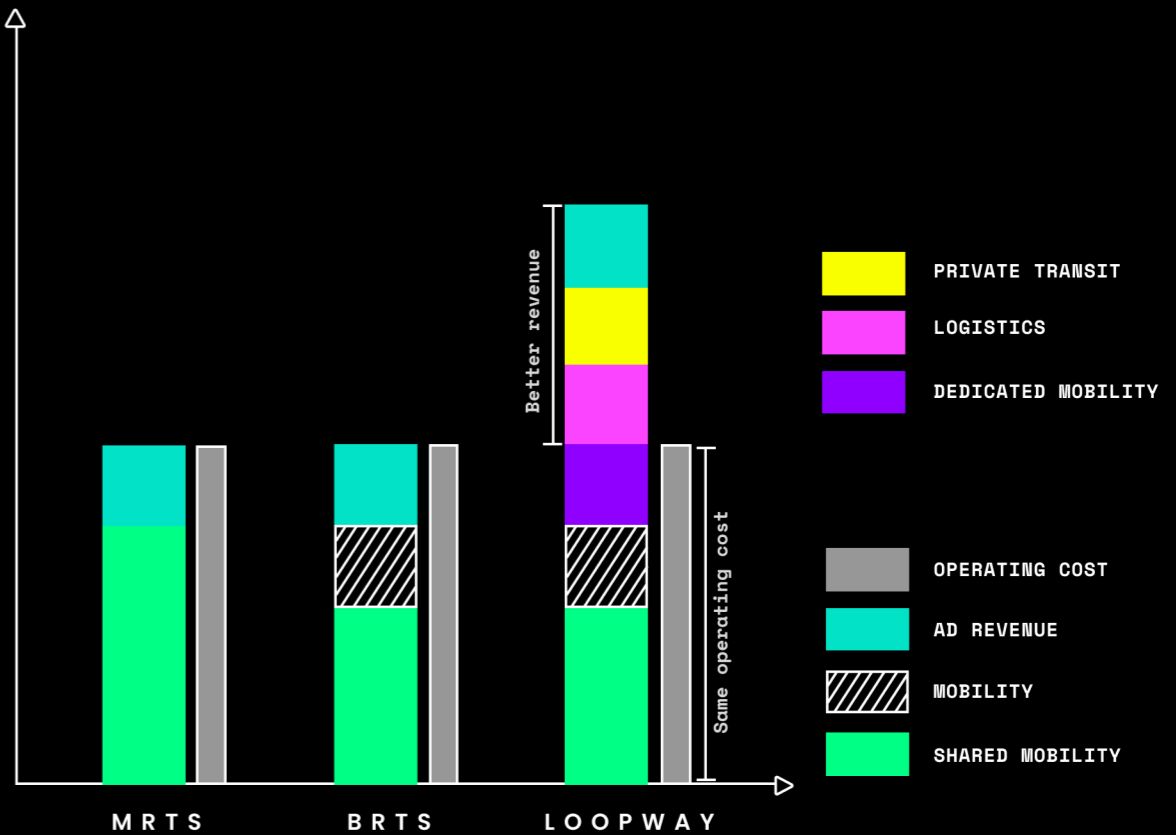

Revenue and operating costs comparison

LOOPWAY



A macro overview of our approach vertically integrating robotics, software, autonomous driving, artificial intelligence and radical boring technologies to build the future of urban mobility

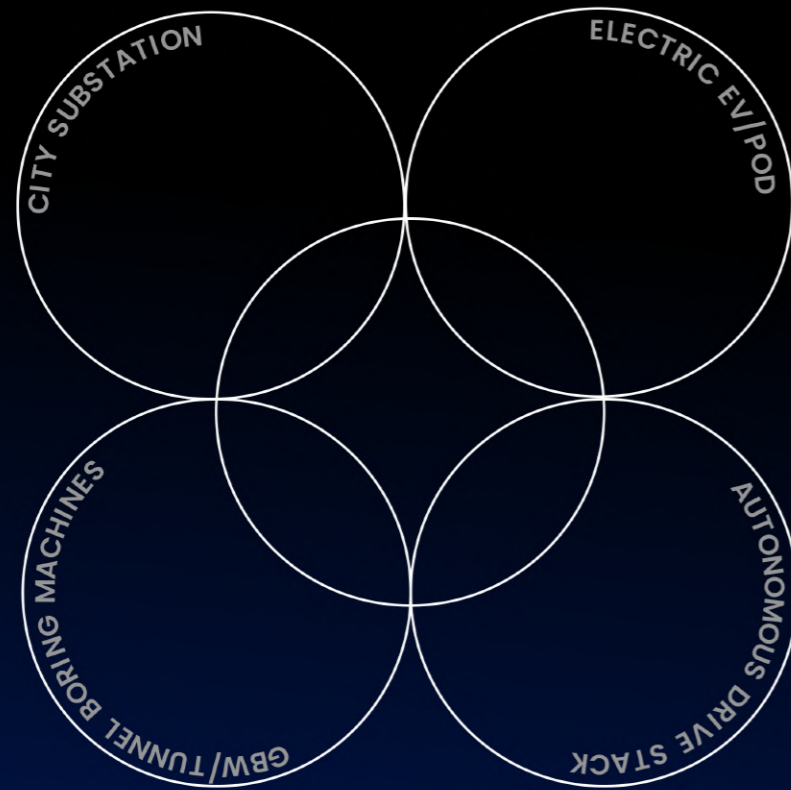

# Vision to Reality

LOOPWAY

## Loopway Tunnel development

TBM . Shaft sinking . Sand removal  
Robotic tunnel reinforcement

## Loopway Autonomous drive

Full self drive . Autonomous software stack  
Sensor Suite Module

## Loopway Hardware and software solutions



V2I Hardware Suite  
(sensors, 5G, LIDAR)



Traffic Management Openics



Vehicle Connectivity



Digital Products

## Loopway Public transport

**Mass Transit**  
Substation Management Software  
Point-of-sale endpoints  
Mobility as a Service(MaaS) Economy/Premium

**Private Transit**  
Hail personal electric ride (UBER/taxi)  
Last mile connectivity

## Loopway Commerical transport

Express goods delivery  
3rd-party businesses integration

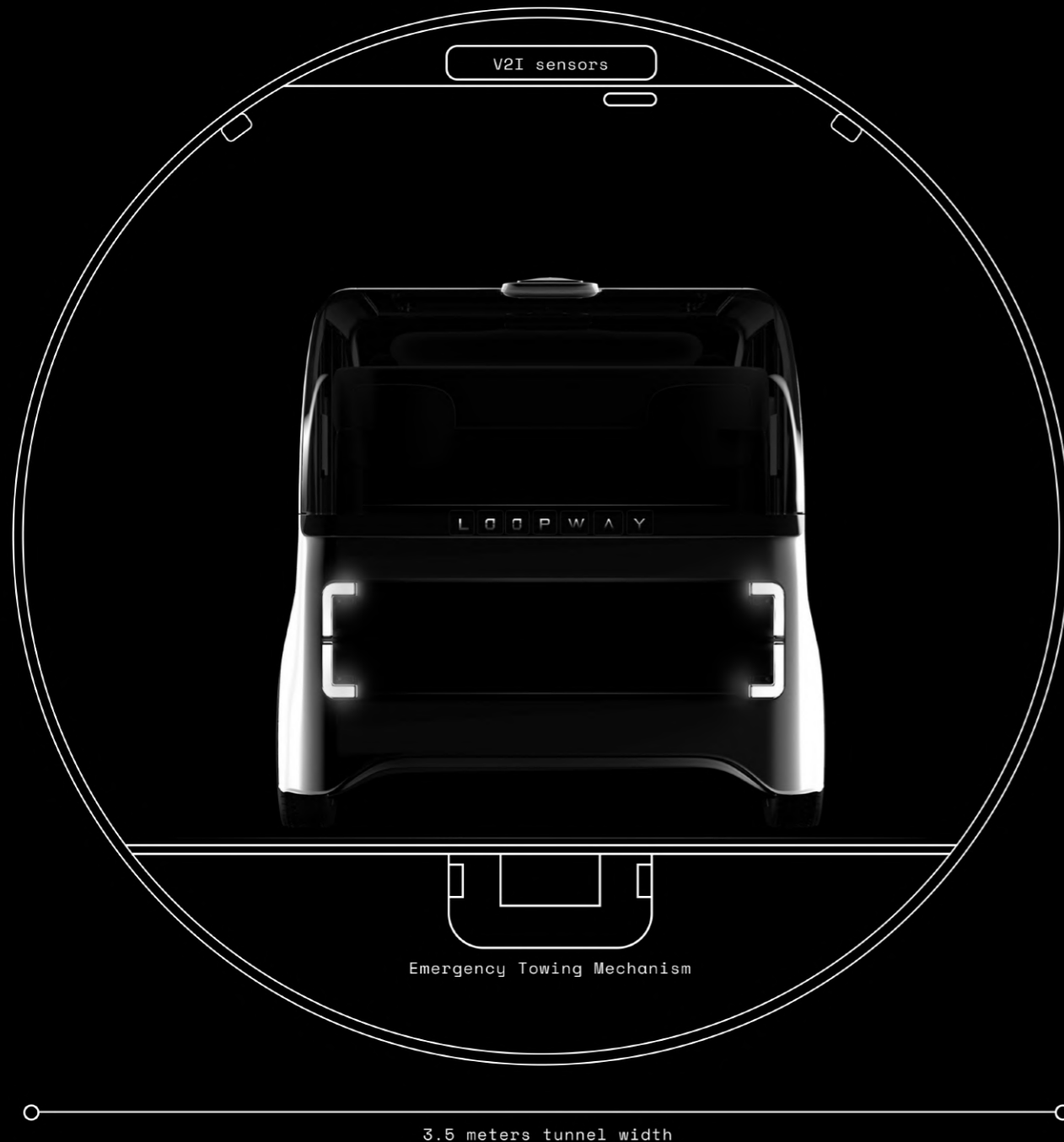

# Tunnel development

**GBW (Geeta Borewells Pvt Ltd)**

GBW, our partner boring company has more than 36 years of expertise in mining and boring industry. Worked with several government agencies and private companies, the company has indigenous developed several Vertical Tunnel Boring Machine using pneumatic cluster drill bit, one of the fastest drilling in the industry.

We have re-engineered entire Tunnel Boring Machines and optimized them from efficient drilling using pneumatic bit, electrifying and automated robotic arms for tunnel reinforcement making the process quiet and suitable for urban environments. Modular and reusable TBM parts for easy assembly and dismantling for replacement helps to bring down the tunneling costs. Local manufacturing in India to optimize the maintenance and boring operations.

## ➤ Custom Tunnel Boring Machines

PNEUMATIC DRILLING

ELECTRIFIED

AUTOMATION/ROBOTIC ARMS

# All electric mobility

DESIGNED FOR RIDERS



**Compact and Safe**  
Sliding doors for easy access



**Spacious Cabin space**  
Equal comfort for every rider

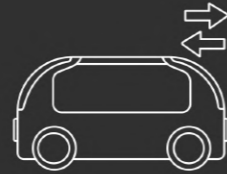

**Bidirectional**



# Loopway / POD

ECONOMY

An everyday ride to work

PREMIUM

A crafted luxury experience

CARGO - LOGISTICS

On time goods delivery, beat the traffic

## 1 Designed for modularity



Our unified platform is designed for multiple usecases, same POD platform with different interior configuration is used across shared mobility, dedicated mobility and logistics areas. The modular electric platform has been designed to be highly customizable to support our consumers and businesses needs.

## 2 3D printing



Using state of art machines and artificial intelligence, the entire POD can be 3D printed with fewer parts faster and at lower costs than the traditional counterparts.



## 3 Micro factories



In contrast to traditional assembly lines, we manufacture our fully purpose-built vehicle using the concept of local microfactories. Rapid, scalable and customised outputs are brought by automated manufacturing and assembly methods.



# > Autonomous driving

Our autonomous stack has been built from ground-up and optimized for use in tunnels. Using industry-leading Sensor for LiDAR, Cameras, IMU, and all required hardware needed for Autonomous Driving. Completely developed, homegrown and indigenous software stack with engineering all over the world.

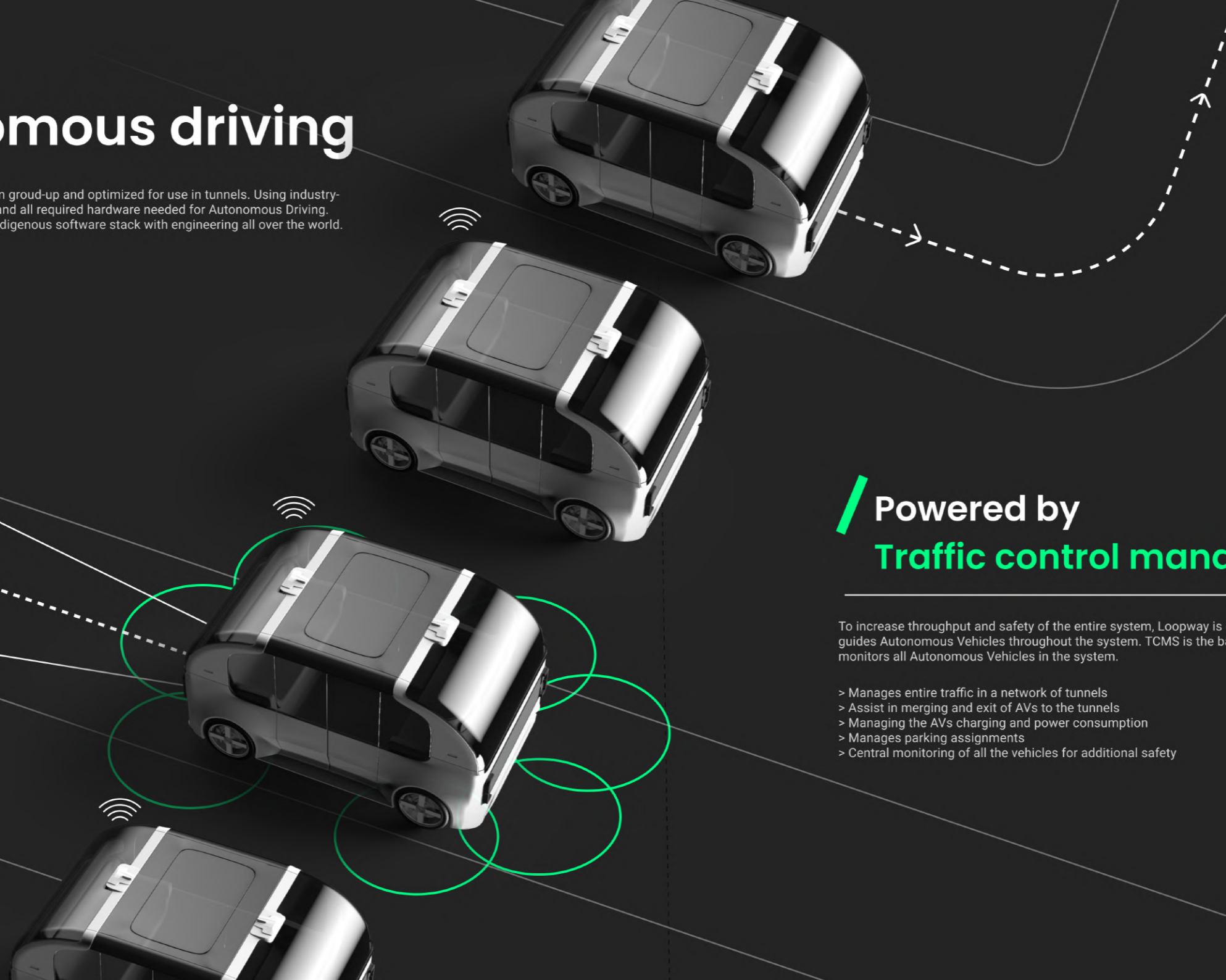

## Powered by Traffic control management system



To increase throughput and safety of the entire system, Loopway is developing Traffic Control Management System which guides Autonomous Vehicles throughout the system. TCMS is the backbone of the entire system which integrates and monitors all Autonomous Vehicles in the system.

- > Manages entire traffic in a network of tunnels
- > Assist in merging and exit of AVs to the tunnels
- > Managing the AVs charging and power consumption
- > Manages parking assignments
- > Central monitoring of all the vehicles for additional safety

# > Digital products

Our range of digital products brings our users and passengers closer to mobility services offered by loopway. Easy ride hailing and enhancing the travel experience, our digital products gives access to the passengers of the upcoming trips, booked add-ons and unique insights about their journey. The administrative tools and dashboards helps fleet managers analyse every vehicle data, its performance and any suspected issues.



Personalized dashboard for passengers

## Book tickets, Add food to seat or Schedule trips

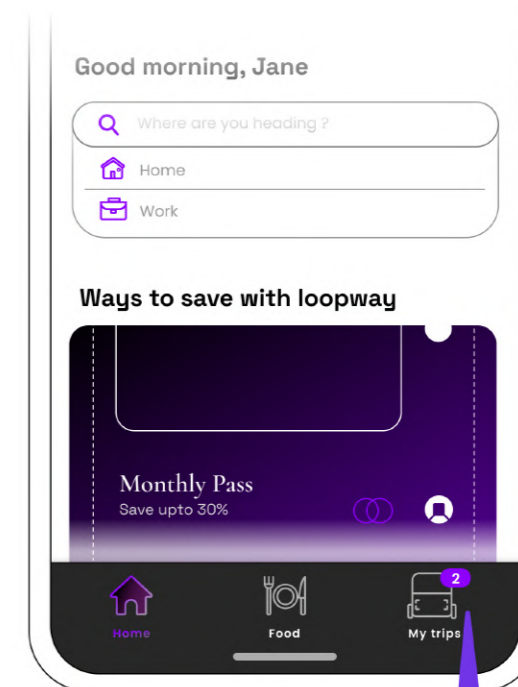
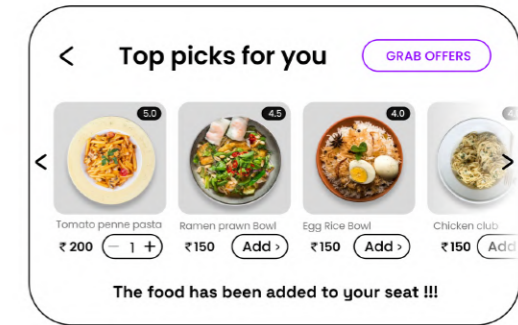
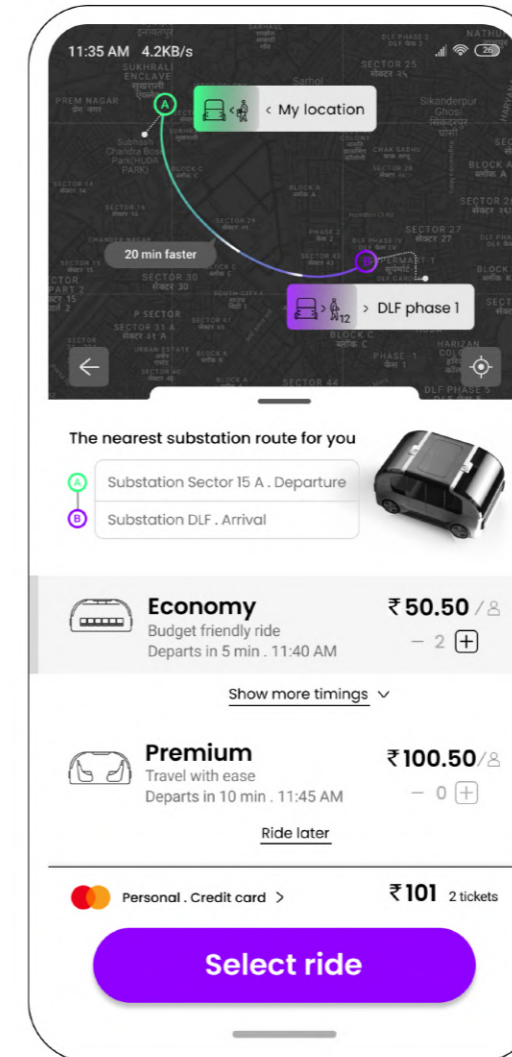

Notifications for all important updates to the trip activity

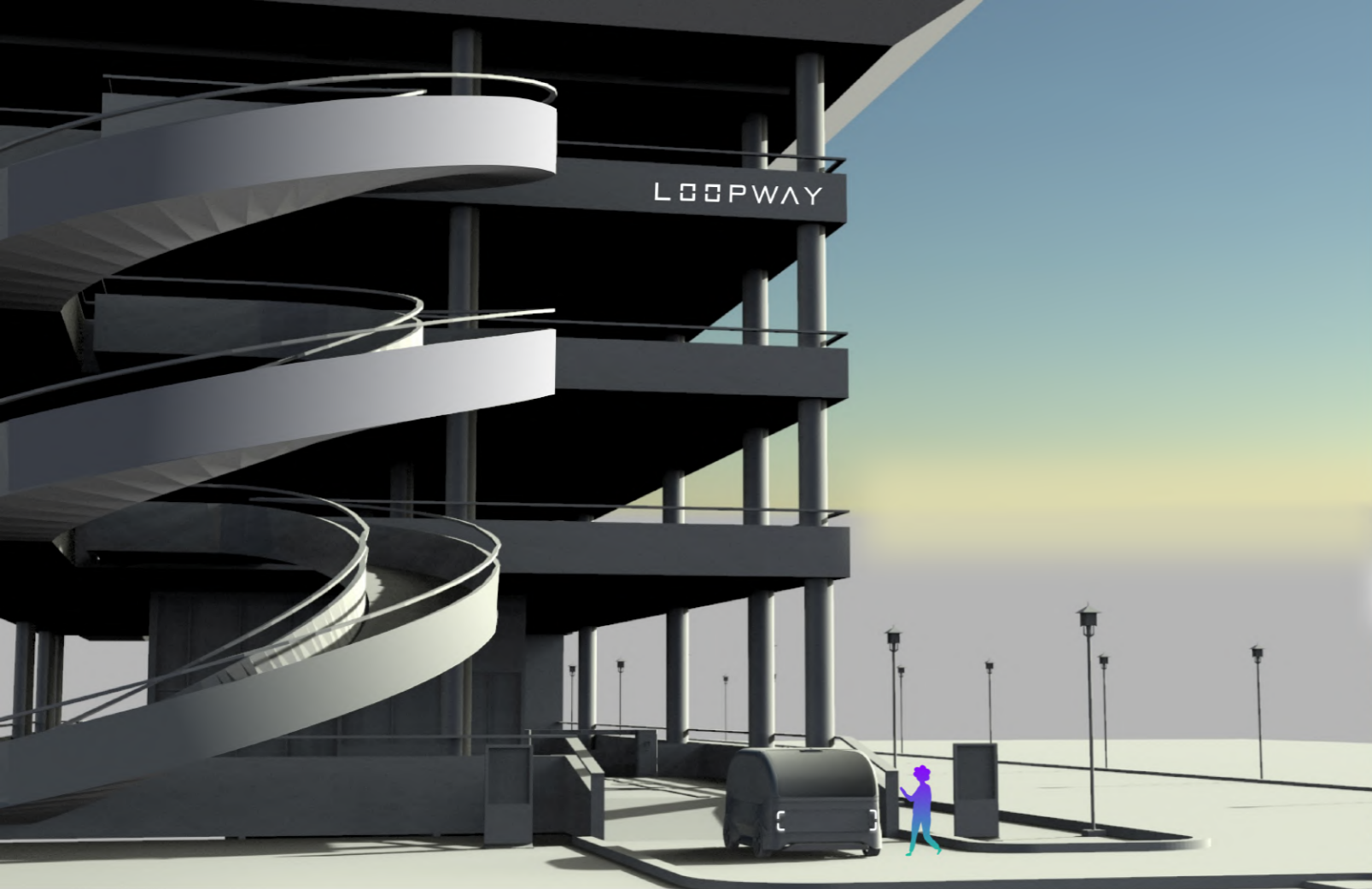

## > Substation design

Substations enables seamless integration between private and public transit systems. We are designing the substation which is capable of integrating autonomous driving with the highest safety standards and using less real estate. The stations are also designed to grow vertically for high-volume places without any more real estate needed.

- > Capacity to serve 100 to 2000 passengers per hour
- > Integrated charging stations
- > Easy ramp-in/ramp-out for private transit to enter and exit tunnels
- > Less disruption while building and operating the substation
- > Vertically scalable

# Loopway / Test Bed

Loopway is building state of an art Testbed for the entire system, including micro tunnels, substations, a control room, and Autonomous Vehicles on 64 acres of land ( 2.8M Sqft). The TestBed will be used for data acquisition purposes for AI training, testing the micro tunnel ventilation system and will serve as a demonstration for all stakeholders.

①

Substation demo

②

Micro tunnel network

③

Control station

④

Merging public and private transit system

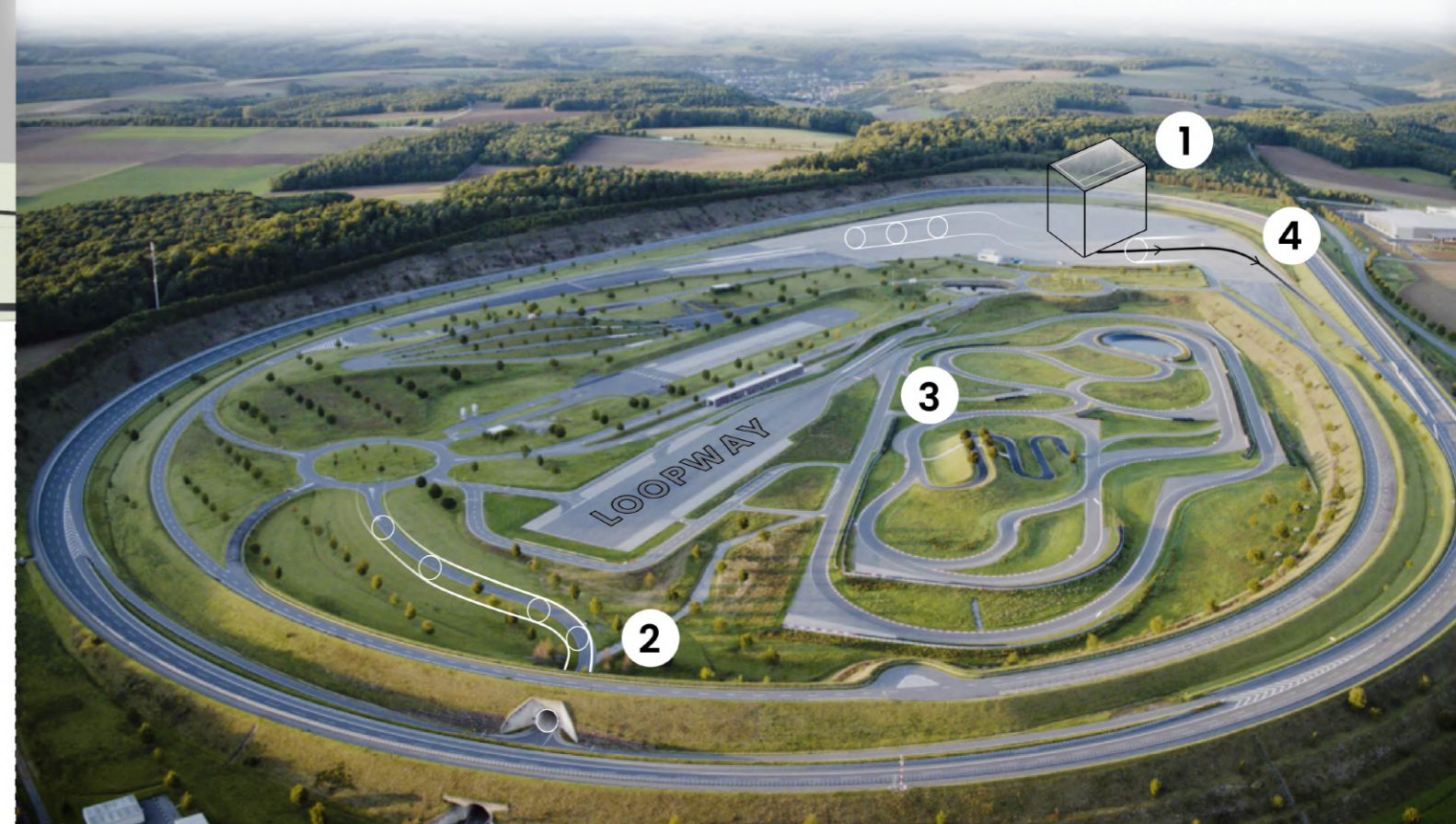

# Pathway to build your city

LOOPWAY



CONSULTING PROGRAM



FACILITATOR PROGRAM

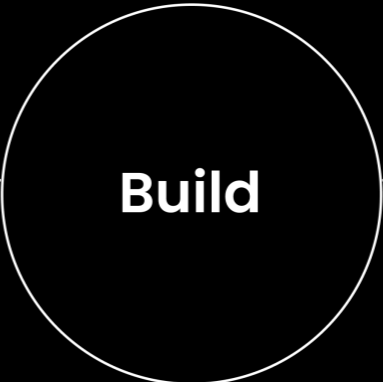

IMPLEMENTATION PROGRAM

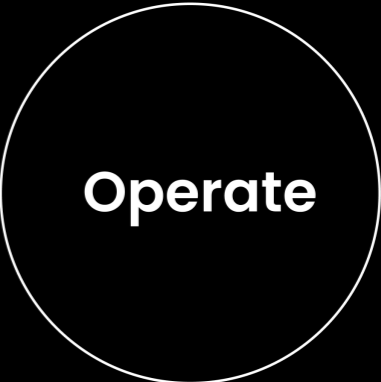

OPERATIONS PROGRAM

# LOOPWAY

---

[www.loopway.in](http://www.loopway.in)

[info@loopway.in](mailto:info@loopway.in)

+91 9391018894